

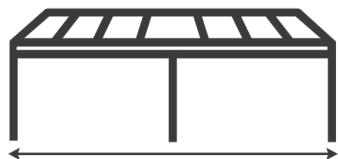

Size Parameters

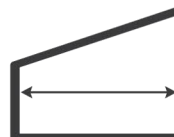

Length
Any Length





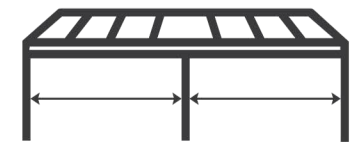



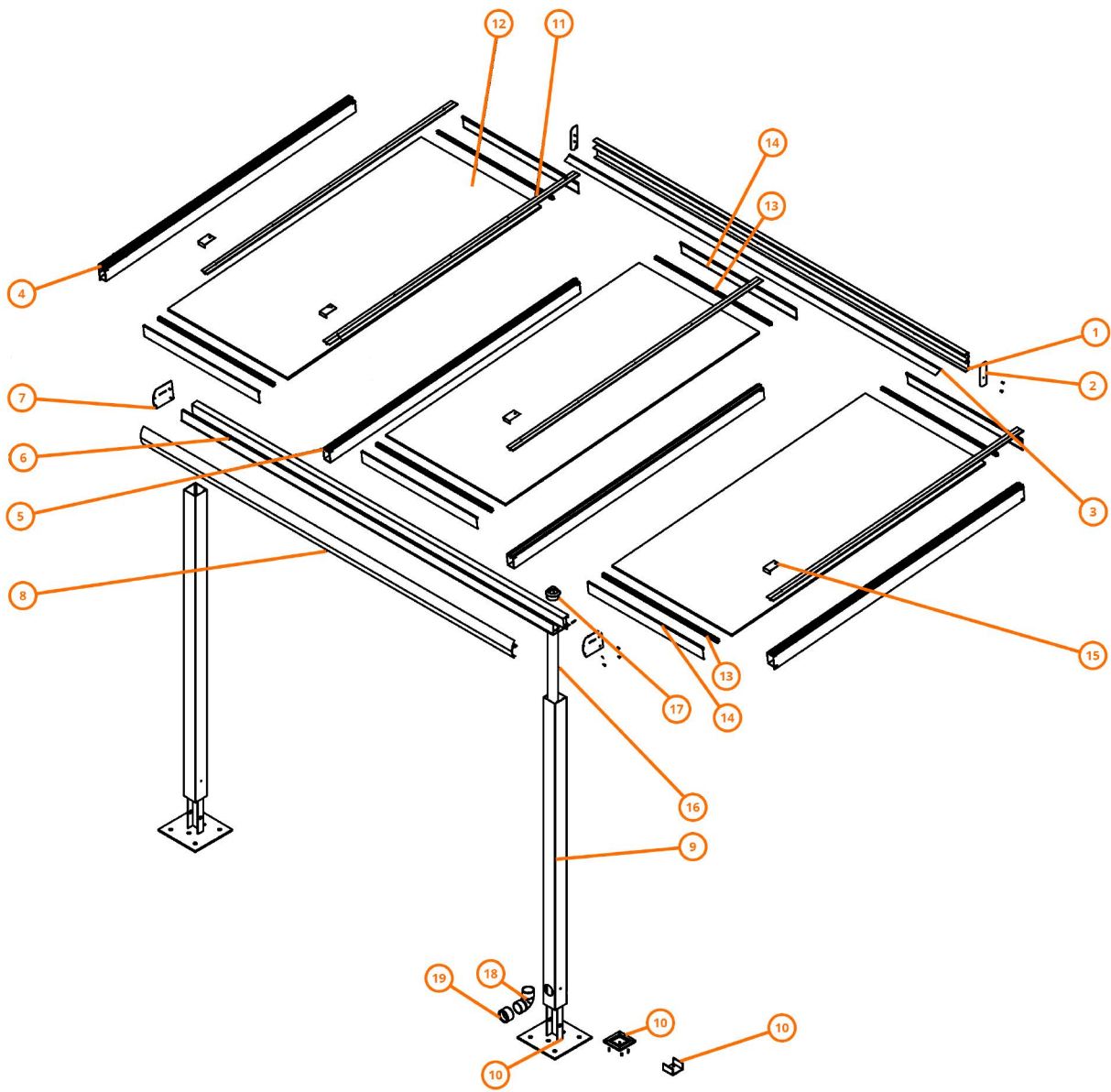

Projection
6m max (polycarbonate roof)
5m max (glass roof)

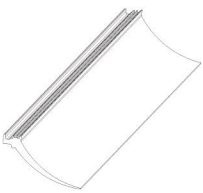
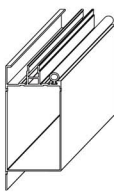
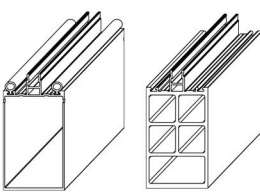
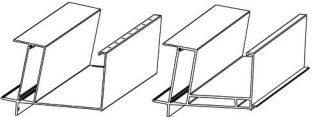
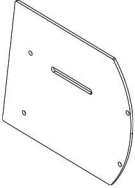
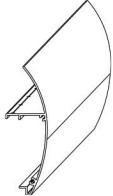
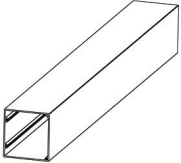
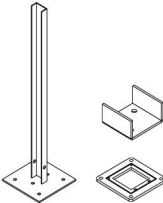
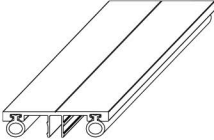
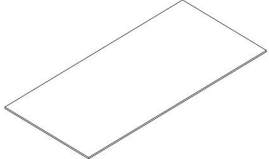

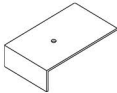
Span Between Posts
6m Span (max projection 4m)
4m Span (4m+ projection)



 <p>1. Wall Plate</p>	 <p>2. End Cap</p>	 <p>3. Wall Plate Rubber</p>	 <p>4. Side Roof Beam</p>	 <p>5. Intermediate Roof Beam</p>	 <p>6. Gutter</p>
 <p>7. Gutter End Cap</p>	 <p>8. Gutter Fascia</p>	 <p>9. 110 x 110mm Square Post</p>	 <p>10. Base Plate</p>	 <p>11. Roof Beam Top Cap</p>	 <p>12. Roof Panel</p>
 <p>13. Nosing (Polycarbonate Only)</p>	 <p>14. Infill Fascia</p>	 <p>15. Roof Beam End Plate</p>	 <p>16. Down Pipe</p>	 <p>17. Leaf Guard</p>	 <p>18. Elbow</p>
 <p>19. Elbow End Cover</p>					

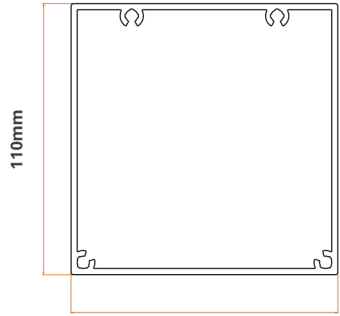

110mm

1. Standard Post

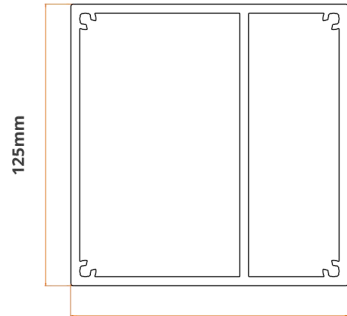

125mm

125mm

2. Heavy Duty Post

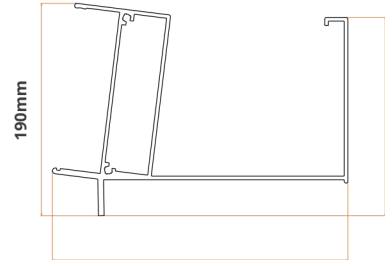

190mm

155mm

3. Standard Gutter

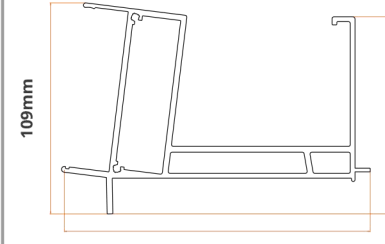

109mm

162mm

4. Heavy Duty Gutter

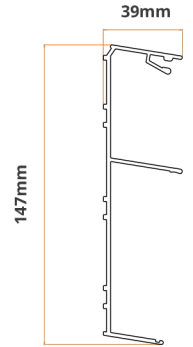

147mm

39mm

5. Wall Plate

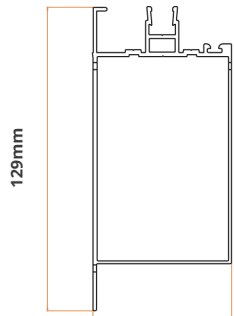

129mm

61mm

6. Side Roof Beam

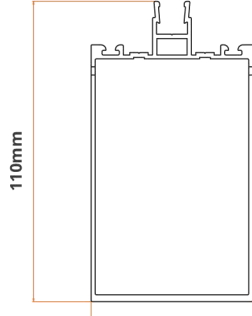

110mm

61mm

7. Intermediate Roof Beam

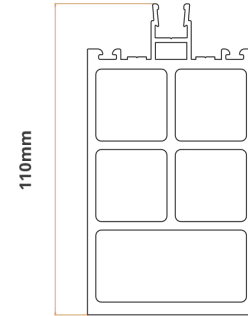

110mm

61mm

8. Heavy Duty Intermediate Roof Beam

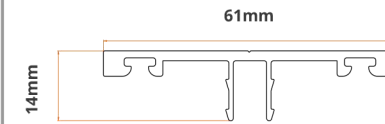

14mm

61mm

9. Roof Beam Top Cap

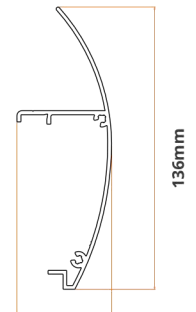

47mm

136mm

10. Radiused Gutter Fascia

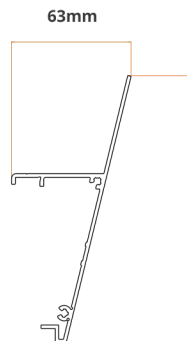

63mm

138mm

11. Angled Gutter Fascia

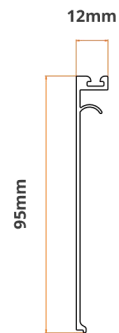

12mm

95mm

12. Infill Fascia

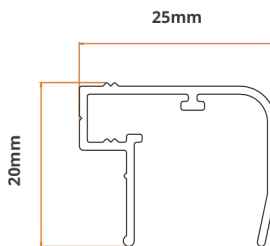

20mm

25mm

13. Nosing For Polycarbonate

7

38 x 4.2mm Pan Head
(2 per roof beam)

1

Anchor Bolts (2 per m)

6

50 x 5.5mm Hex Head

2

Post

32 x 55mm Hex Head

Anchor Bolts

Surface Mounted Concealed Base Plate

Concealed Surface Mounted Base Plate

5

50 x 5.5mm Hex Head
(1 per 0.5m)

4

32 x 5.5mm Hex Head
(1 per m)

50 x 5.5mm Hex Head

19 x 4.2mm Pan Head
(1 per m)

32 x 5.5mm Hex Head

3

38 x 4.2mm Pan Head
(2 per roof beam)

2

Finished Ground Surface

Post

Anchor Bolts

Steel Base Plate

Bolt-on Below Ground Base Plate

2

Post

Base Plate

Concrete

Cast-in Base Plate

